

Betriebsdruck: 0 – 10 bar  
 Temperaturbereich: -10 °C bis +60 °C

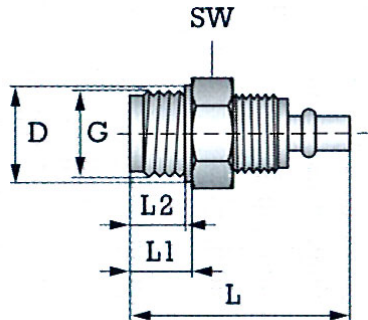

11.653

### Gerade Einschraubverschraubungen, Außengewinde zylindrisch

Artikel Nr.	Typen Nr.	Gewinde	für Schlauch mm	NW mm	SW mm	D mm	L mm	L <sub>1</sub> mm	L <sub>2</sub> mm
110721	11.651	G 1/8	6/4	3,0	13	11,0	28,0	7,0	6,0
110722	11.652	G 1/8	8/6	4,5	13	11,0	29,5	7,0	6,0
110723	11.653	G 1/4	6/4	3,0	17	14,5	31,0	9,0	8,0
110724	11.654	G 1/4	8/6	4,5	17	14,5	32,0	9,0	8,0
110725	11.655	G 1/4	12/9	7,0	19	16,0	37,5	9,0	8,0
110726	11.656	G 1/4	10/8	6,5	17	14,5	34,0	9,0	8,0
110727	11.657	G 3/8	8/6	4,5	19	18,5	34,0	11,0	10,0
110728	11.658	G 3/8	10/8	6,5	19	18,5	35,5	11,0	10,0
110729	11.659	G 3/8	12/9	7,0	19	18,5	37,5	11,0	10,0

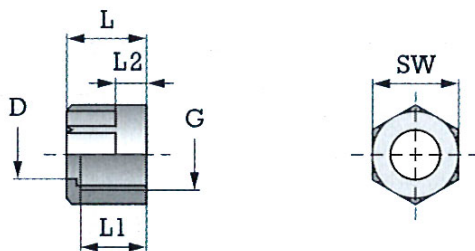

Artikel Nr.	Typen Nr.	für Schlauch mm	Gewinde	SW mm	D mm	L mm	L <sub>1</sub> mm	L <sub>2</sub> mm
110721, 110723	11.651, 11.653	6/4	M10x1	12	6,2	13,0	10,5	5,0
110722, 110724, 110727	11.652, 11.654, 11.657	8/6	M12x1	14	8,2	13,0	10,5	5,0
110726, 110728	11.656, 11.658	10/8	M14x1	17	10,2	13,0	11,0	6,0
110725, 110729	11.655, 11.659	12/9	M16x1	19	12,4	14,0	11,5	6,0

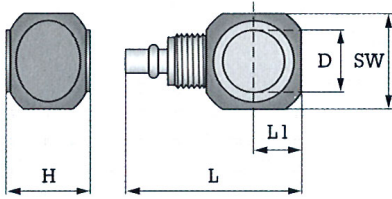

13.665

Winkel-Verschraubungen mit Alu-Hohlschraube, drehbar

Artikel Nr.	Typen Nr.	Gewinde	für Schlauch mm	NW mm	SW mm	D mm	L mm	L <sub>1</sub> mm	H mm
110730	13.660	G 1/8	6/4	3,0	16	10,0	31,0	8,0	16,5
110731	13.661	G 1/8	8/6	4,5	16	10,0	33,0	8,0	16,5
110732	13.665	G 1/4	6/4	3,0	20	13,0	35,0	10,0	16,5
110733	13.666	G 1/4	8/6	4,5	20	13,0	36,5	10,0	16,5

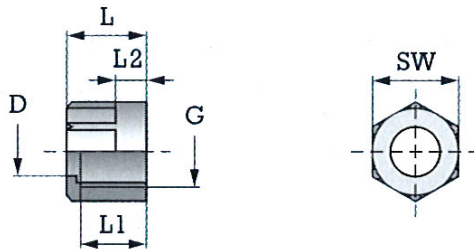

Artikel Nr.	Typen Nr.	für Schlauch mm	Gewinde	SW mm	D mm	L mm	L <sub>1</sub> mm	L <sub>2</sub> mm
110730, 110731	13.660, 13.661	6/4	M10x1	12	6,2	13,0	10,5	5,0
110732, 110733	13.665, 13.666	8/6	M12x1	14	8,2	13,0	10,5	5,0

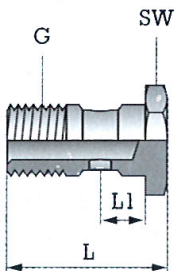

Artikel Nr.	Typen Nr.	Gewinde	L mm	L <sub>1</sub> mm	L <sub>2</sub> mm	SW mm	Werkstoff
110730, 110731	13.660, 13.661	G 1/8	27,0	8,0	8,0	14	Alu eloxiert blau
110732, 110733	13.665, 13.666	G 1/4	29,0	10,0	8,0	17	Alu eloxiert blau

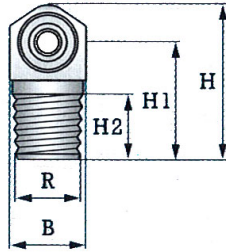
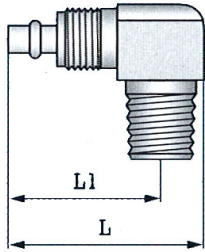

13.765

**Winkel-Verschraubungen, starr, Außengewinde konisch, Gewinde nach ISO 7-1**

Artikel Nr.	Typen Nr.	Gewinde	für Schlauch mm	NW mm	B mm	L mm	L <sub>1</sub> mm	H mm	H <sub>1</sub> mm	H <sub>2</sub> mm
110734	13.760	R 1/8	6/4	3	11,0	29,0	23,0	22,0	16,0	8,0
110735	13.761	R 1/8	8/6	5	14,0	29,0	23,0	24,0	17,0	8,0
110736	13.765	R 1/4	6/4	3	14,0	32,0	24,0	25,0	19,0	11,0
110737	13.766	R 1/4	8/6	5	14,0	33,0	25,0	27,0	20,0	11,0
110738	13.768	R 1/4	12/9	7	17,0	36,0	28,0	33,0	23,0	13,0
110739	13.774	R 3/8	12/9	7	17,0	36,0	28,0	33,0	23,0	13,0

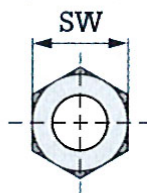
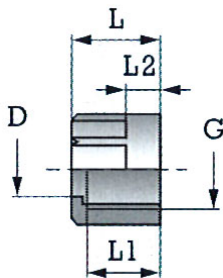

Artikel Nr.	Typen Nr.	für Schlauch mm	Gewinde	SW mm	D mm	L mm	L <sub>1</sub> mm	L <sub>2</sub> mm
110734, 110736	13.760, 13.765	6/4	M10x1	12	6,2	13,0	10,5	5,0
110735, 110737	13.761, 13.766	8/6	M12x1	14	8,2	13,0	10,5	5,0
110738, 110739	13.768, 13.774	12/9	M16x1	19	12,4	14,0	11,5	6,0

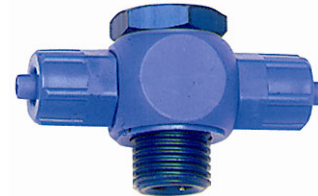
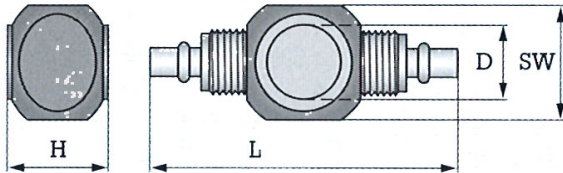

14.815

T-Verschraubungen mit Alu-Hohlschraube, drehbar

Artikel Nr.	Typen Nr.	Gewinde	für Schlauch mm	NW mm	SW mm	D mm	L mm	H mm
110740	14.811	G 1/8	6/4	3	16	10,0	47,0	16,5
110741	14.812	G 1/8	8/6	5	16	10,0	49,0	16,5
110742	14.815	G 1/4	6/4	3	20	13,0	51,0	16,5
110743	14.816	G 1/4	8/6	5	20	13,0	53,0	16,5

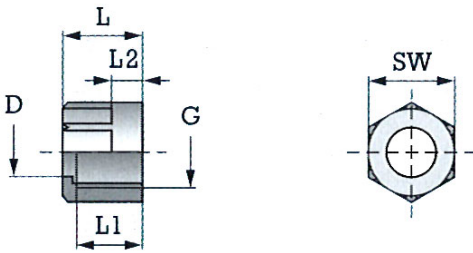

Artikel Nr.	Typen Nr.	für Schlauch mm	Gewinde	SW mm	D mm	L mm	L <sub>1</sub> mm	L <sub>2</sub> mm
110740, 110741	14.811, 14.815	6/4	M10x1	12	6,2	13,0	10,5	5,0
110742, 110743	14.812, 14.816	8/6	M12x1	14	8,2	13,0	10,5	5,0

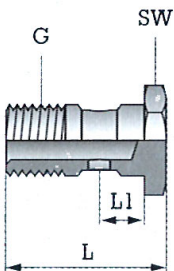

Artikel Nr.	Typen Nr.	Gewinde	L mm	L <sub>1</sub> mm	L <sub>2</sub> mm	SW mm	Werkstoff
110740, 110741	14.811, 14.812	G 1/8	27,0	8,0	8,0	14	Alu eloxiert blau
110742, 110743	14.815, 14.816	G 1/4	29,0	10,0	8,0	17	Alu eloxiert blau

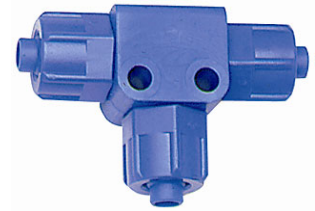
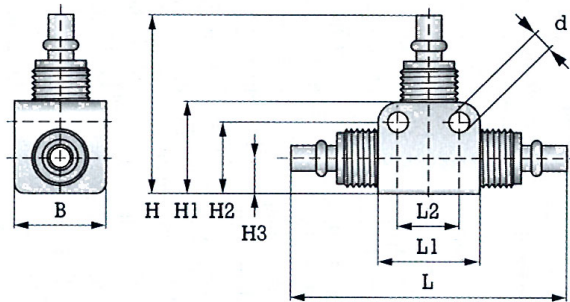

14.912

**T-Verbinder, starr**

Artikel Nr.	Typen Nr.	für Schlauch mm	NW mm	L mm	L <sub>1</sub> mm	L <sub>2</sub> mm	B mm	d mm	H mm	H <sub>1</sub> mm	H <sub>2</sub> mm	H <sub>3</sub> mm
110744	14.911	6/4	3	52,0	20,0	12,0	15,0	4,3	32,0	16,0	12,0	6,0
110745	14.912	8/6	5	52,0	20,0	12,0	18,0	4,3	34,0	18,0	14,0	8,0
110746	14.913	12/9	7	63,0	25,0	15,5	22,0	4,3	40,0	21,0	16,5	8,0

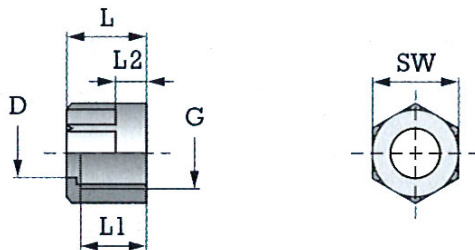

Artikel Nr.	Typen Nr.	für Schlauch mm	Gewinde	SW mm	D mm	L mm	L <sub>1</sub> mm	L <sub>2</sub> mm
110744	14.911	6/4	M 10x1	12	6,2	13,0	10,5	5,0
110745	14.912	8/6	M 12x1	14	8,2	13,0	10,5	5,0
110746	14.913	12/9	M 16x1	19	12,4	14,0	11,5	6,0

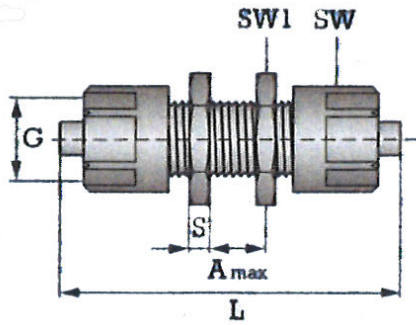

15.776

### Gerade Schlauchverbindungen

Artikel Nr.	Typen Nr.	für Schlauch mm	Gewinde	NW mm	L	A <sub>max</sub>	SW	SW <sub>1</sub>	S
110747	15.775	6/4	M10x1	3	50,5	10	12	13	3
110748	15.776	8/6	M12x1	7	51,3	10	14	17	3
110749	15.778	12/9	M16x1	7	59,8	10	19	19	4

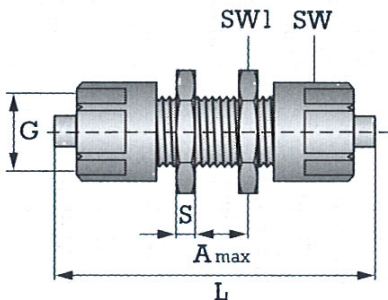

15.886

### Schottverbinder komplett mit Befestigungsmutter

Artikel Nr.	Typen Nr.	Gewinde	für Schlauch mm	NW mm	L mm	A <sub>max</sub> mm	SW mm	SW <sub>1</sub> mm	S mm
110750	15.885	M10x1,0	6/4	3	50,0	10,0	12	13	3,0
110751	15.886	M12x1,0	8/6	4	51,0	10,0	14	17	3,0
110752	15.888	M16x1,0	12/9	7	60,0	10,0	19	19	4,0

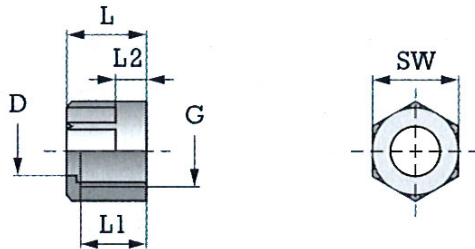

Artikel Nr.	Typen Nr.	für Schlauch mm	Gewinde	SW mm	D mm	L mm	L <sub>1</sub> mm	L <sub>2</sub> mm
110750	15.885	6/4	M10x1,0	12	6,2	13,0	10,5	5,0
110751	15.886	8/6	M12x1,0	14	8,2	13,0	10,5	5,0
110752	15.888	12/9	M16x1,0	19	12,4	14,0	11,5	6,0

### Befestigungsmutter für Schottverbinder

Artikel Nr.	Typen Nr.	für Schlauch mm	Gewinde	S mm
110750	15.885	6/4	M10x1,0	3,0
110751	15.886	8/6	M12x1,0	3,0
110752	15.888	12/9	M16x1,0	4,0

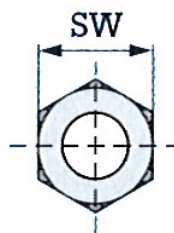
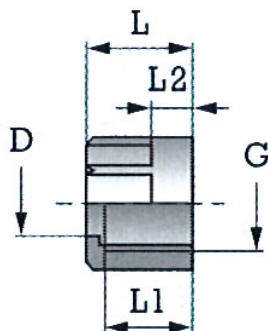

16/13

### Klemm-Muttern

Artikel Nr.	Typen Nr.	für Schlauch	Gewinde	SW mm	D mm	L mm	L <sub>1</sub> mm	L <sub>2</sub> mm
110753	16/12	6/4	M10x1,0	12	6,2	13,0	10,5	5,0
110754	16/13	8/6	M12x1,0	14	8,2	13,0	10,5	5,0
110755	16/14	12/9	M16x1,0	19	12,4	14,0	11,5	6,0
110756	16/15	10/8	M14x1,0	17	10,2	13,0	11,0	6,0

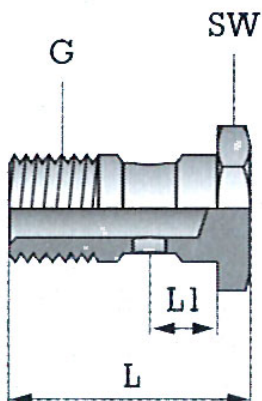

14/11

### Hohlschrauben aus Aluminium

Artikel Nr.	Typen Nr.	Gewinde	L mm	L <sub>1</sub> mm	L <sub>2</sub> mm	SW mm	Werkstoff
110757	14/11	G 1/8	27,0	8,0	8,0	14	Alu eloxiert blau
110758	14/12	G 1/4	29,0	10,0	8,0	17	Alu eloxiert blau

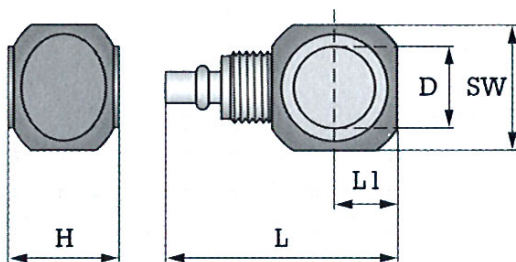

13/14

### Einfach-Ringstutzen

Artikel Nr.	Typen Nr.	Gewinde	für Schlauch mm	NW mm	SW mm	D mm	L mm	L <sub>1</sub> mm	H mm
110759	13/11	G 1/8	6/4	3	16	10,0	31,0	8,0	16,5
110760	13/12	G 1/8	8/6	5	16	10,0	33,0	8,0	16,5
110761	13/14	G 1/4	6/4	3	20	13,0	35,0	10,0	16,5
110762	13/15	G 1/4	8/6	5	20	13,0	36,5	10,0	16,5